



# MasterSeal Roof Waterproofing Guide

Durable Roofing Solutions  
with Liquid Resin Systems



## Master Builders Solutions from BASF

### Master Builders Solutions

The Master Builders Solutions brand brings all of BASF's expertise together to create chemical solutions for new construction, maintenance, repair and renovation of structures. Master Builders Solutions is built on the experience gained from more than a century in the construction industry.



The know-how and experience of a global community of BASF construction experts form the core of Master Builders Solutions. We combine the right elements from our portfolio to solve your specific construction challenges. We collaborate across areas of expertise and regions and draw on the experience gained from countless construction projects worldwide.

We leverage global BASF technologies, as well as our in-depth knowledge of local building needs, to develop innovations that help make you more successful and drive sustainable construction.

The comprehensive portfolio under the Master Builders Solutions brand encompasses concrete admixtures, cement additives, chemical solutions for underground construction, waterproofing solutions, sealants, concrete repair & protection solutions, performance grouts, performance flooring and tiling solutions.

### Contents

|  |  |
|--|--|
| 03 _ Master Builders Solutions from BASF                   | 10 _ Hand Applied Systems  |
| 04 _ Roof Waterproofing                                    | 11 _ Detailing   |
| 06 _ MasterSeal Roof Liquid Systems for Roof Waterproofing | 12 _ System Solutions  |
| 08 _ MasterSeal Roof Systems Layout                        | 14 _ Risk Management: Basf System Products for Successful Projects |
| 09 _ Spray Applied Systems                                 |  |





## Roof Waterproofing

Any building needs an external protection just like a “skin” to avoid its deterioration through the effects of natural elements and weathering. As part of the building envelope, roofs have a decisive role in the durability of the structure as, being the top surface of the building, prevent water penetration through horizontal or slightly inclined surfaces. All these factors make roofs as one of the most critical parts in a structure.

This is the reason why roof leakages are often the most visible and commonly claimed for damage in a building as inadequate roofing affects the functionality of the entire structure.

Roof protects not only the building itself but also the goods and the equipment installed below. This is why a good performance of the roof not only improves the durability of the building but also secures the investment in materials and production assets in industrial buildings.

A durable roof waterproofing system which resists the temperature changes and environmental aggressions such as pollution and acid rain is therefore a vital part of the building envelope.





## MasterSeal Roof Liquid Systems for Roof Waterproofing

MasterSeal® Roof systems form a fully bonded, seamless waterproofing membrane that avoids welds and seams that are typically the weaker spots in any waterproofing system. MasterSeal Roof systems can be installed on most substrates, including old concrete, built-up felt asphalt and timber substrates.

MasterSeal® Roof systems allow for simple applications on roofs with build-ups, penetrations and complicated structures. Also leaking roofs can be repaired in many cases without removing the old waterproofing layer. This offers clear time and cost savings and reduces the costs for disposal of old membranes.



### Unlimited surfaces

Liquid systems allow easy detailing creating a waterproof membrane around details quickly.

### Long term service life

MasterSeal® Roof systems can be applied on exposed surfaces exposed to a high range of temperatures, weathering and rain conditions. Long term durability in this conditions without rigidisation, softening or UV related damages. This special properties allow a service life up to 25 years.



### Easy detailing

Liquid systems allow application of a continuous membrane on large surfaces without limitations.



### Applicable in shaped substrates

Perfect forming in shaped surfaces. Spray applied systems can be applied on horizontal, vertical and sloped surfaces.



### No disruption of normal activities

Business can proceed normally during application of MasterSeal Roof systems. Conditioning systems and/or installations can continue uninterrupted.



### Lightweight

Adding minimal dead load on the roofs. Only approx. 3 kg/m<sup>2</sup>.



### For new and refurbished roofs

Application is possible on any substrate type, even on existing roofs without the need of removal of previous waterproofing systems.

### Quick hardening

Application of different parts of the system can proceed without delays or downtimes as spray applied membranes harden very quickly.



### Quick installation

Application using spray equipment can achieve application yields up to 1,000 m<sup>2</sup> per day.



## The MasterSeal Roof Systems Layout

The MasterSeal® Roof waterproofing systems are composed of 3 product layers that are applied fully bonded on the substrate. The clever combination of these layers contributes to the performance and the durability of the system.

### 1 MasterSeal® P primers

are an important component of the system to ensure the adhesion of the waterproofing system to all substrates. Fully bonded membrane systems prevent the water circulation between the layers even if there is a leakage, helping its detection, localization and repair.

### 2 MasterSeal® M membranes

provide waterproofing capacities to the system. Once cured, MasterSeal M membranes have high elasticity and crack bridging properties, necessary to avoid water leakages in case of moving cracks in substrates. Membranes can be one or two components and can be spray or hand applied.

### 3 MasterSeal® TC topcoats

protect the membrane from the action of weather and UV light. Topcoats are optional in some cases but always contribute to improve the durability of the waterproofing system and the aesthetical appearance of the finished roof.

### 4 Substrate

MasterSeal Roof waterproofing systems can be applied, fully bonded, to most substrates including concrete, steel, cement screed, glass, reinforced polyester, timber etc.

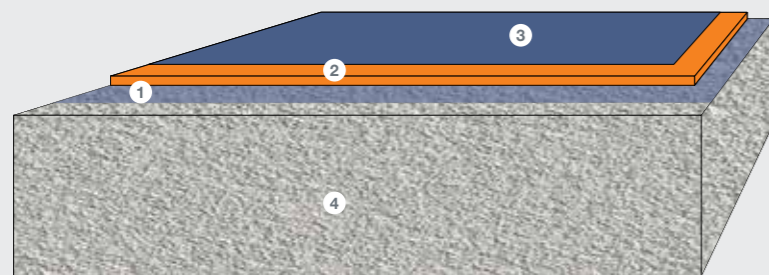

- 1 MasterSeal® P primers
- 2 MasterSeal® M membranes
- 3 MasterSeal® TC topcoats
- 4 Substrate



## Spray Applied Systems

### MasterSeal® Roof 2689

Roof waterproofing system based on 1:1 spray applied polyurea membrane.

1:1 Spray applied, 100 % polyurea, membrane with quick reaction time. Full operational after only 2 hours.

- 1 Topcoat (optional) – MasterSeal® TC 258  
2 x 0.15 kg/m<sup>2</sup>
- 2 Membrane – MasterSeal® M 689  
2–2.5 kg/m<sup>2</sup>
- 3 Primer – MasterSeal® P  
(according substrate)

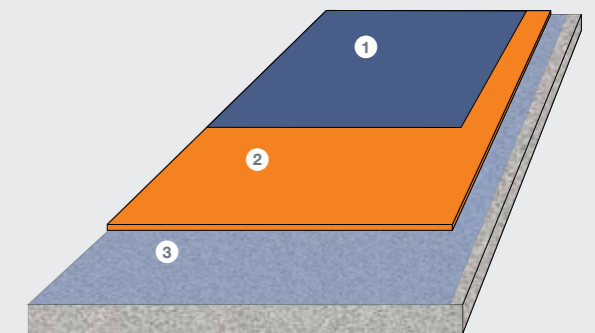

### MasterSeal® Roof 2111

Roof waterproofing system based on 1:1 spray applied membrane for applications with no fire retardancy requirement.

1:1 Spray applied membrane with quick reaction time. Full operational after 2 days.

- 1 Alternative topcoat – MasterSeal® TC 258  
1 x 0.3-0.4 kg/m<sup>2</sup>
- 2 Membrane – MasterSeal® M 811  
2–2.5 kg/m<sup>2</sup>
- 3 Primer – MasterSeal® P  
(according substrate)

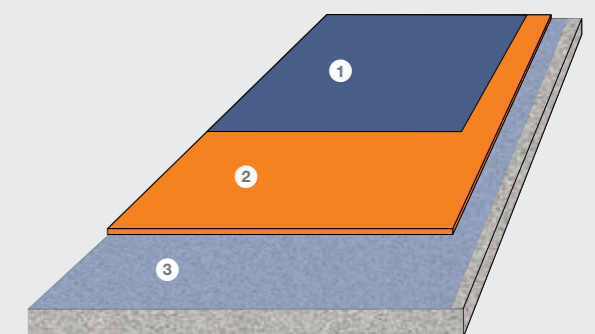



## Hand Applied Systems

### MasterSeal® Roof 2166

Roof waterproofing system based on the hand applied 2K membrane for applications with no fire retardancy requirement.

Hand applied membrane with long workability time, fully hardened and operational after 4 days.

- 1 Alternative topcoat – **MasterSeal® TC 258**  
1 x 0.3-0.4 kg/m<sup>2</sup>
- 2 Membrane – **MasterSeal® M 860**  
2 x 0.5 kg/m<sup>2</sup>
- 3 Primer – **MasterSeal® P**  
(according substrate)

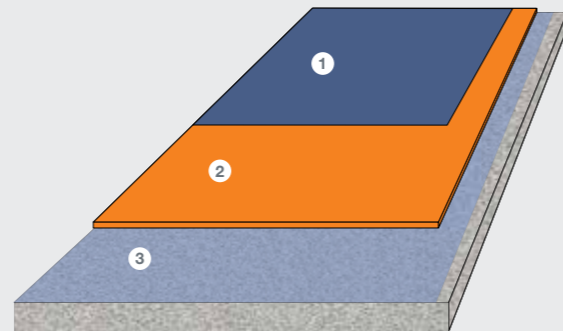

### MasterSeal® Roof 2164

Roof waterproofing system based on the hand applied 1K membrane according to guideline ETAG 005-06. With ETA 09/0396.

Single-component, low viscosity hand or air-less applied membrane recoatable and ready for pedestrian traffic only after 12 hours.

- 1 Topcoat – **MasterSeal® TC 640**  
2 x 0.15 kg/m<sup>2</sup>
- 2 Membrane – **MasterSeal® M 640**  
2 x 0.7 kg/m<sup>2</sup>
- 3 Primer – **MasterSeal® P 640**  
(according substrate)

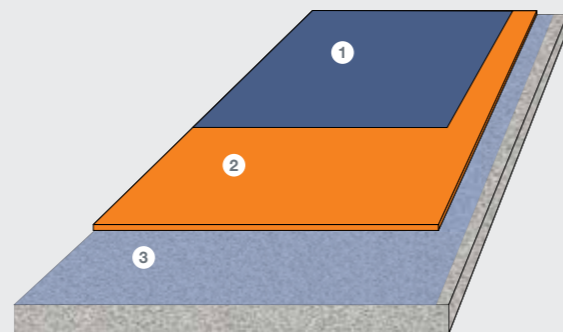

## Detailing

Liquid systems allow easy detailing creating the membrane around the details quickly without the need of seams, prefabricated moulded parts, mechanical fixings or

additional flashings. See below, as guidance purposes only, some common solutions for most needed details in roofs.

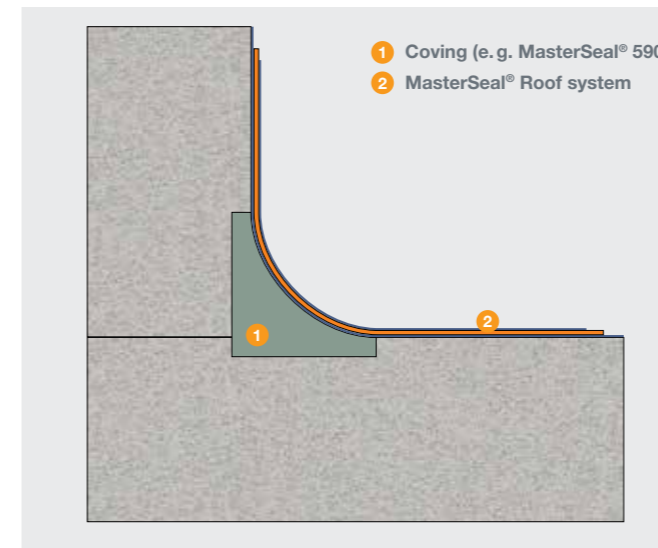

**Detail 1:** View of the specific detailing solution for horizontal – vertical connections.

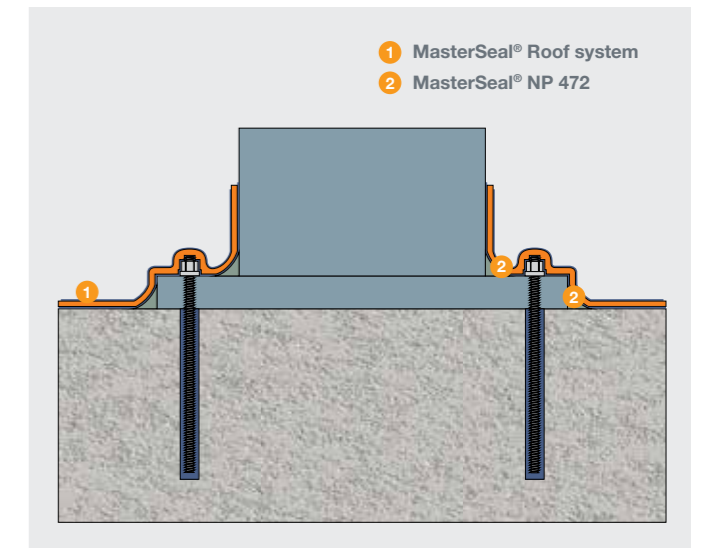

**Detail 2:** View of the specific detailing solution for surface mounted installations.

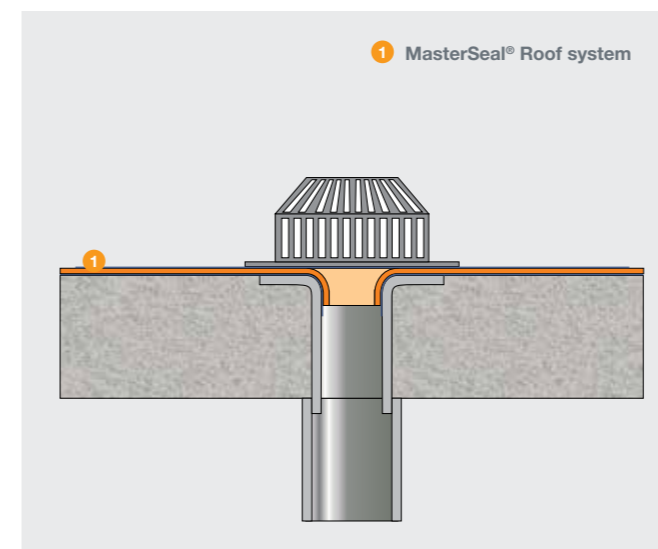

**Detail 3:** View of the specific detailing solution for membrane continuity in drains.

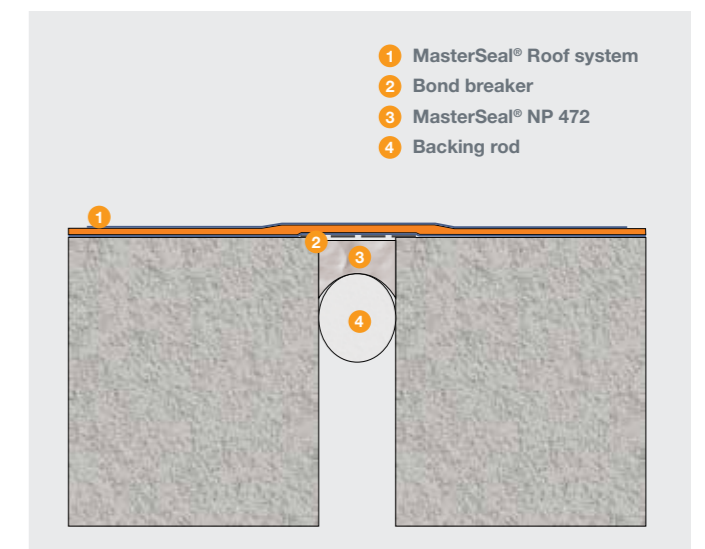

**Detail 4:** View of the specific detailing solution for movement joints.



# System Solutions

Inverted roof, with gravel protection

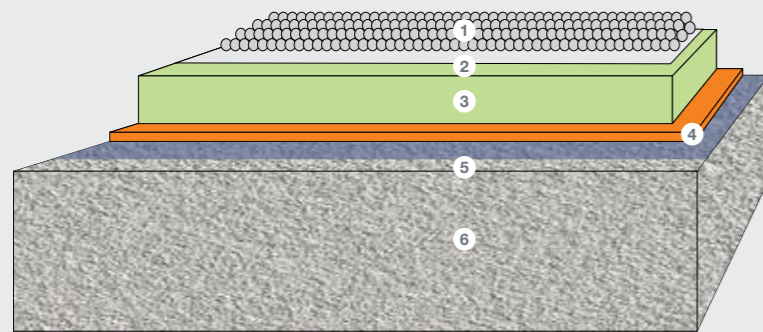

- 1 Gravel
- 2 Geotextile
- 3 Styrodur
- 4 Membrane
- 5 Primer
- 6 Substrate

Green roof

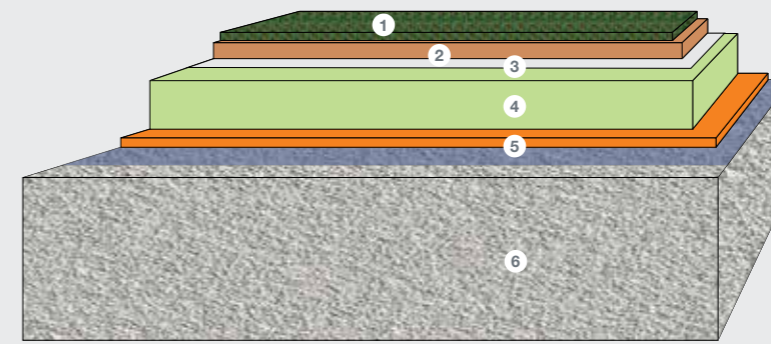

- 1 Grass and plants
- 2 Soil
- 3 Geotextile
- 4 Styrodur
- 5 Membrane
- 6 Primer
- 7 Substrate

Inverted roof, with tiling protection

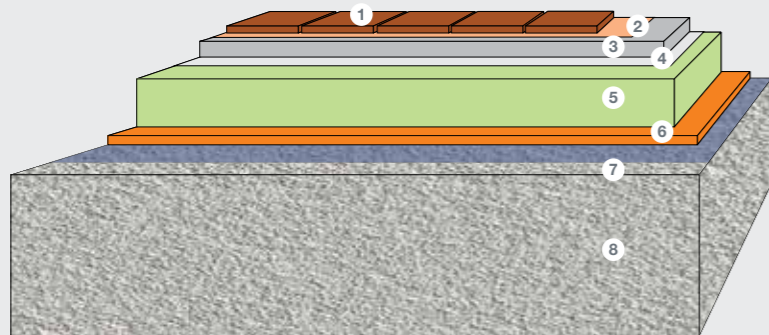

- 1 Tiles
- 2 Tile adhesive
- 3 Mortar
- 4 Geotextile
- 5 Styrodur
- 6 Membrane
- 7 Primer
- 8 Substrate

Insulated roof with PU foam

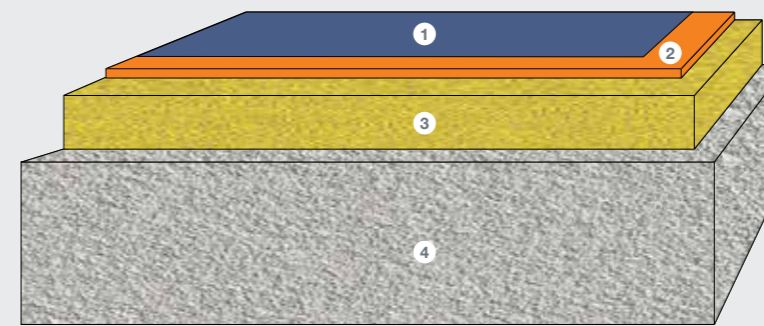

- 1 Topcoat
- 2 Membrane
- 3 PU foam insulation
- 4 Substrate

Sandwich panel

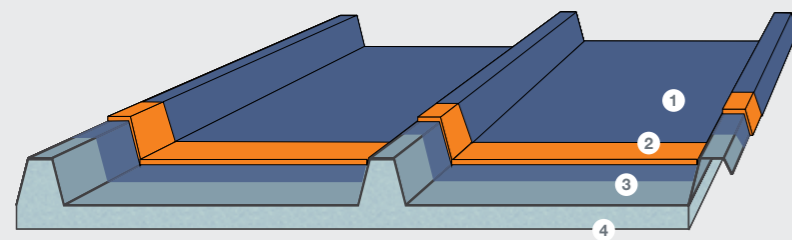

- 1 Topcoat
- 2 Membrane
- 3 Primer
- 4 Sandwich panel



# Risk Management: BASF System Products for Successful Projects

This guide illustrates the waterproofing of different types of roofs. Whatever the area to be treated, several components are required. The right combination and compatibility are essential to ensure successful performance.

Based on our global knowledge of construction physics and our experience and track record in the repair and waterproofing of several structures, we know that Risk Management is a unique and relevant topic in the construction industry and requires reliability in all respects, including products, full system solutions (from membranes to detailing products), professional consultancy, approved and warrantied application, etc.

Causes of construction failures and the probability of their occurrence have been identified following several surveys in Europe, resulting in four basic categories of deficiency: Design, Construction, Materials, Use and Maintenance.

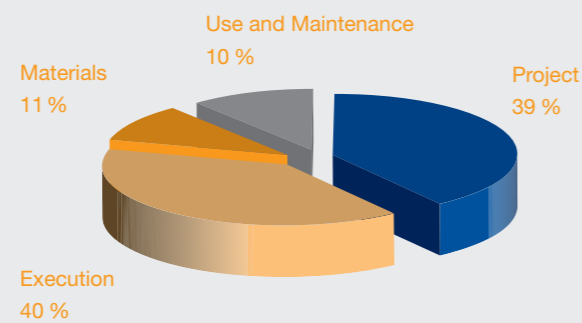

To control these risks and secure their investment, owners, investors, general contractors and engineers first and foremost need complete waterproofing solutions supplied by a reliable manufacturer with proven experience in Risk Management.

Risk Management provided by BASF focuses on reducing the probability of the occurrence of the causes that have been identified as damage generators:

- Detailed analysis of needs and review of specifications and drawings to ensure perfect waterproofing.
- Improving planning reliability of waterproofing installation objectives with defined product systems that include not only waterproofing membranes but also detailing such as joint treatment, crack injection, substrate repair, etc.
- Ensuring greater certainty about technical application and projected durability based on expert workmanship.
- Managing installation via BASF Licensed Contractors and/or BASF Approved Applicators.

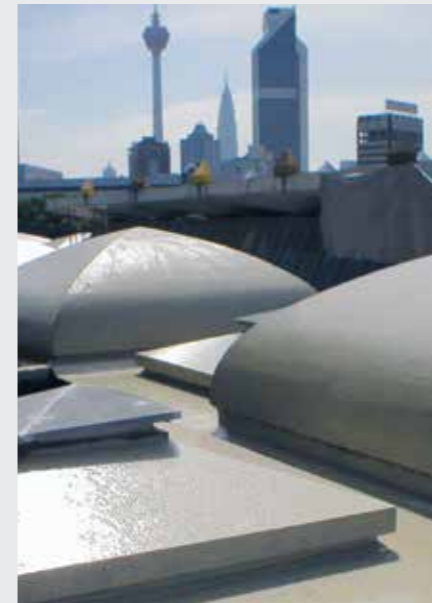

## 1 Experience:

Our Master Builders Solutions experts solve challenges on jobsites worldwide. This is proven by our extensive list of job references.



## 5 Detailing:

We understand the necessary products and solution approach, including details (joints, transition points, penetrations, etc.) that are often neglected, although they represent the most vulnerable points.

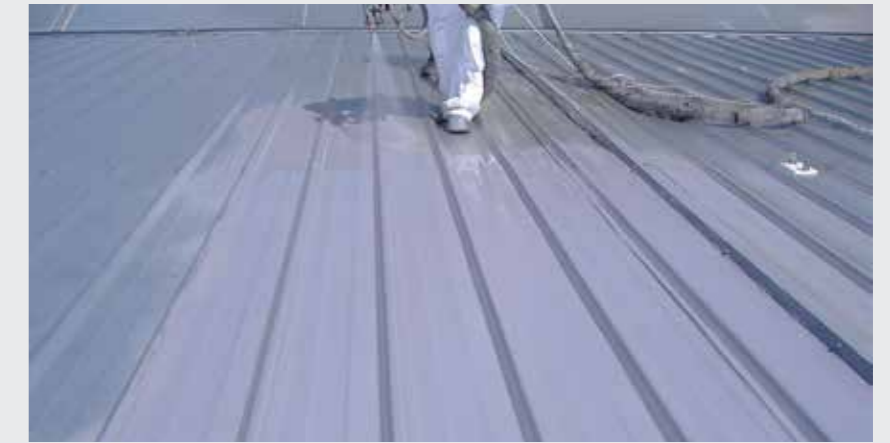

## 2 Expertise in application:

BASF System Partners, following an intensive and continued training programme, offer the reliable and professional application of systems. This ensures the successful completion of jobs and, thus, long-term serviceable structures. Our exclusive BASF System Warranty includes a documented application carried out by a BASF System Partner.



## 3 Design and specification:

Our Master Builders Solutions experts contribute to the analysis and design process, combining single products into complete system solutions.



## 4 Product systems:

Products with high performance characteristics are required in this and all other applications, but it is always essential that these products are designed and thus certified for the specific intended use. Our comprehensive range of waterproofing systems under the Master Builders Solutions is documented and certified in different European countries for use in the waterproofing of different building areas.





# Master Builders Solutions from BASF for the Construction Industry

## MasterAir®

Complete solutions for air entrained concrete

## MasterBrace®

Solutions for concrete strengthening

## MasterCast®

Solutions for the manufactured concrete product industry

## MasterCem®

Solutions for cement manufacture

## MasterEmaco®

Solutions for concrete repair

## MasterFinish®

Solutions for formwork treatment

## MasterFlow®

Solutions for precision grouting

## MasterFiber®

Comprehensive solutions for fiber reinforced concrete

## MasterGlenium®

Solutions for hyperplasticized concrete

## MasterInject®

Solutions for concrete injection

## MasterKure®

Solutions for concrete curing

## MasterLife®

Solutions for enhanced durability

## MasterMatrix®

Advanced rheology control solutions for self-consolidating concrete

## MasterPel®

Solutions for water tight concrete

## MasterPolyheed®

Solutions for mid-range concrete

## MasterPozzolith®

Solutions for water-reduced concrete

## MasterProtect®

Solutions for concrete protection

## MasterRheobuild®

Solutions for high strength concrete

## MasterRoc®

Solutions for underground construction

## MasterSeal®

Solutions for waterproofing and sealing

## MasterSet®

Solutions for set control

## MasterSure®

Solutions for extraordinary workability retention

## MasterTile®

Solutions for tiling systems

## MasterTop®

Solutions for industrial and commercial floors

## Master X-Seed®

Advanced accelerator solutions for concrete

## Ucrete®

Flooring solutions for harsh environments

## Contact us:

United Arab Emirates  
**BASF CONSTRUCTION CHEMICALS UAE LLC**  
Dubai : +971 4 8090800  
Abu Dhabi: +971 2 5512262  
[www.master-builders-solutions.basf.ae](http://www.master-builders-solutions.basf.ae)

### Regional Offices

Bahrain : +973 1 7786427  
Oman : +968 2 4218596

Kuwait : +965 2 4742533  
[www.master-builders-solutions.basf.com.kw](http://www.master-builders-solutions.basf.com.kw)

Algeria  
**BASF CONSTRUCTION CHEMICALS ALGERIA SARL**  
Tel : +213 21 309509  
[www.basf.com.dz](http://www.basf.com.dz)

Azerbaijan  
**BASF Caspian CC LLC**  
Tel : +994 18 6531030  
[www.master-builders-solutions.basf.az](http://www.master-builders-solutions.basf.az)

Egypt  
**BASF CONSTRUCTION CHEMICALS EGYPT SAE**  
Tel : +2 02 25980800  
[www.master-builders-solutions.basf.com.eg](http://www.master-builders-solutions.basf.com.eg)

Kazakhstan  
**BASF CENTRAL ASIA LLP**  
Tel : +7 7272 790013  
[www.master-builders-solutions.basf.kz](http://www.master-builders-solutions.basf.kz)

Kenya  
**BASF EAST AFRICA LIMITED**  
Tel : +254 20 4443454  
[www.master-builders-solutions.basf.co.ke](http://www.master-builders-solutions.basf.co.ke)

Morocco  
**BASF MAROC SA**  
Tel : +212 522 669939  
[www.master-builders-solutions.basf.co.ma](http://www.master-builders-solutions.basf.co.ma)

Near East  
**JORDANIAN SWISS COMPANY FOR MANUFACTURING AND MARKETING CONSTRUCTION CHEMICALS**  
Tel : +962 6 5521672  
[www.basf-cc.com.jo](http://www.basf-cc.com.jo)

Nigeria  
**BASF WEST AFRICA LIMITED**  
Tel : +234 1 4607483  
[www.master-builders-solutions.basf.ng](http://www.master-builders-solutions.basf.ng)

Russia  
**BASF STROITELNYE SISTEMY**  
Tel : +7 495 2256436  
[www.master-builders-solutions.basf.ru](http://www.master-builders-solutions.basf.ru)

Saudi Arabia  
**SAUDI BASF FOR BUILDING MATERIALS CO. LTD**  
Tel : +966 3 8121140  
[www.master-builders-solutions.sa](http://www.master-builders-solutions.sa)

South Africa  
**BASF CONSTRUCTION CHEMICALS SOUTH AFRICA (PTY) LTD**  
Tel : +27 11 203 2405  
[www.master-builders-solutions.basf.co.za](http://www.master-builders-solutions.basf.co.za)

Turkey  
**BASF CONSTRUCTION CHEMICALS**  
Tel : +90 216 5703400  
[www.master-builders-solutions.basf.com.tr](http://www.master-builders-solutions.basf.com.tr)

Ukraine  
**BASF T.O.V**  
Tel : +380 44 5915595  
[www.master-builders-solutions.basf.ua](http://www.master-builders-solutions.basf.ua)